

SEARS

OWNER'S MANUAL

Model Nos.
565. 66100
565. 66101

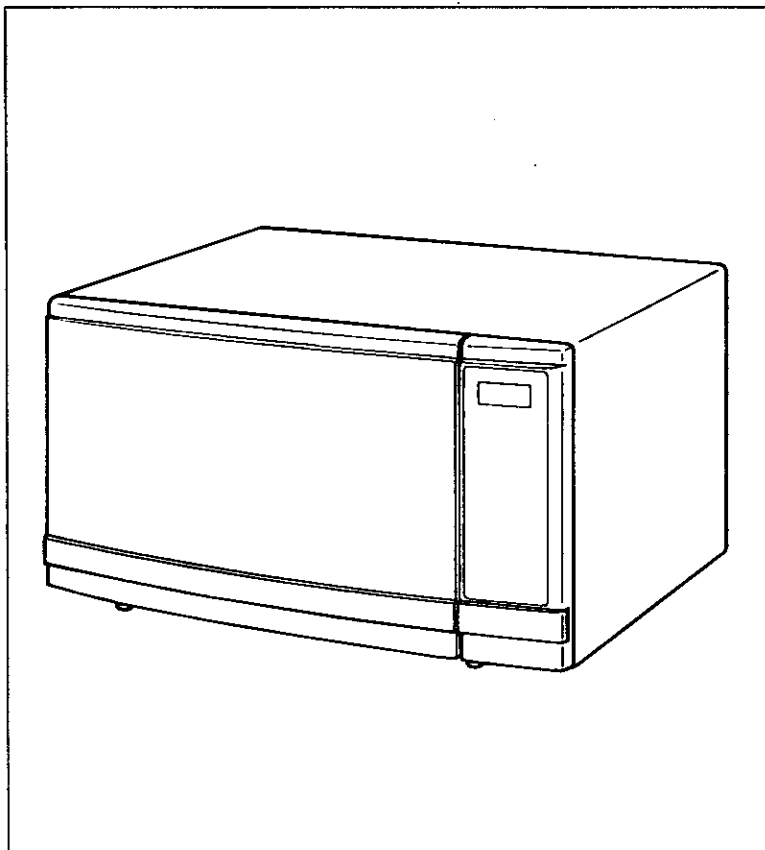

Caution:

Read these instructions carefully before use.

If you follow the instructions, your microwave oven will provide you with many years of good service.

Precaución:

Lea atentamente estas instrucciones antes de la utilización.

MICROWAVE OVEN

- Safety Instructions (English & Spanish)
- Installation (English & Spanish)
- Operation (English & Spanish)
- Care and Service

**SAVE THESE INSTRUCTIONS
GUARDE ESTAS INSTRUCCIONES**

Thank you for purchasing this Kenmore Microwave Oven !

FOR YOUR ASSISTANCE...

To make a request for service, information or replacement of parts, Sears will require the complete **Model number** and **Serial number** of your oven. The Model number and the Serial number are found on the label on the front of oven.

Copy your Model and Serial numbers here.

Model No. _____

Serial No. _____

Date of Purchase _____

PROPER AND SAFE USE OF YOUR OVEN

- **The oven** must be level.
- **The turntable and turntable roller rest** must be in the oven during cooking.
- **Place** the cookware gently on the turntable and handle it carefully to avoid possible breakage.
- **Incorrect use** of browning dish may cause the turntable to break. See page 8.
- **Use** only the specified bag size when using Automatic Popcorn.
- **The oven** has several built-in safety switches to ensure that the power remains off when the door is open. Do not tamper with these switches.
- **Do not** operate the microwave oven empty. Operating the oven with no food or food that is extremely low in moisture can cause fire, charring or sparking.
- **Do not** cook bacon directly on the turntable. Excessive local heating of the turntable may cause it to break.
- **Do not** heat baby bottles or baby food in the microwave oven. Uneven heating may occur and could cause physical injury.
- **Do not** heat narrow-necked containers, such as syrup bottles.
- **Do not** attempt to deep-fry in your microwave oven.
- **Do not** do home canning in this microwave oven as it is impossible to be sure all contents of the jar have reached boiling temperature.
- **Do not** use this microwave oven for commercial purposes. This microwave oven is made for household use only.

PRECAUTIONS TO AVOID POSSIBLE EXPOSURE TO EXCESSIVE MICROWAVE ENERGY

- (a) **Do not** attempt to operate this oven with the door open since open-door operation can result in harmful exposure to microwave energy. It is important not to defeat or tamper with the safety interlocks.
- (b) **Do not** place any object between the oven front face and the door or allow soil or cleaner residue to accumulate on sealing surfaces.
- (c) **Do not** operate the oven if it is damaged. It is particularly important that the oven door closes properly and that there is no damage to the:
 - (1) DOOR (bent)
 - (2) HINGES AND LATCHES (broken or loosened)
 - (3) DOOR SEALS AND SEALING SURFACES
- (d) **The oven** should not be adjusted or repaired by anyone except properly qualified service personnel.

IMPORTANT SAFETY INSTRUCTIONS

Before Operation

When using electrical appliances, basic safety precautions should be followed, including the following:

 **WARNING** – To reduce the risk of burns, electric shock, fire, injury to persons or exposure to excessive microwave energy:

1. **Read** all instructions before using the appliance.
2. **Read and follow** the specific "PRECAUTIONS TO AVOID POSSIBLE EXPOSURE TO EXCESSIVE MICROWAVE ENERGY" on the previous page.
3. As with most cooking appliances, close supervision is necessary to reduce the risk of a fire in the oven cavity.

If a fire should start:

- Keep the oven door closed
- Turn the oven off, and
- Disconnect the power cord or shut off power at the fuse or circuit breaker panel.

Keep in mind the following rules at all times:

- a. **Do not** overcook foods. Carefully attend the appliance if paper, plastic, or other combustible materials are placed inside the oven to facilitate cooking.
 - b. **Do not** use the cavity for storage purposes. Do not store combustible items such as bread, cookies, paper products, etc. inside the oven. If lightning strikes the power line, the oven may turn on by itself.
 - c. **Do not** use wire twist-ties in the oven. Be sure to inspect purchased items for wire twist-ties and remove before placing them in the oven.
4. **This oven** must be grounded. Connect only to properly grounded outlet. See "GROUNDING INSTRUCTIONS" on page 2.
 5. **Install or locate** this oven only in accordance with the provided installation instructions.
 6. **Some products** such as whole eggs and sealed containers — for example water with oil or fat and closed glass jars — may explode and therefore should not be heated in this oven.

7. **Use** this appliance only for its intended use as described in the manual. Do not use corrosive chemicals or vapors in this appliance. This type of oven is specifically designed to heat, cook or dry food. It is not designed for industrial or laboratory use.
8. As with any appliance, close supervision is necessary when used by children.
9. **Do not** operate this oven if it has a damaged cord or plug, if it is not working properly or if it has been damaged or dropped.
10. **This appliance** should be serviced only by qualified service technicians. Contact the nearest authorized service facility for examination, repair or adjustment.
11. **Do not** cover or block any vents on the oven.
12. **Do not** store or use this appliance outdoors.
13. **Do not** use this oven near water, near a kitchen sink, in a wet basement or near a swimming pool, and the like.
14. **Do not** immerse cord or plug in water.
15. **Keep** cord away from heated surfaces.
16. **Do not** let cord hang over edge of table or counter.
17. **When cleaning** surfaces of door and oven that comes together on closing the door, use only mild, nonabrasive soaps or detergents applied with a sponge or soft cloth. (See "Cleaning" instructions on page 17.)
18. **Do not** operate any heating or cooking appliance beneath this appliance.
19. **Do not** mount unit over or near any portion of a heating or cooking appliance.
20. **Do not** mount over a sink.
21. **Do not** store anything directly on top of the appliance surface when the appliance is in operation.

SAVE THESE INSTRUCTIONS

ELECTRICAL GROUNDING INSTRUCTIONS

DANGER - Electric Shock Hazard

Do not disassemble this appliance. Touching some of the internal components, even if the appliance is unplugged, can result in electric shock that can cause serious personal injury or death.

This appliance must be grounded. If there is an electrical short circuit, grounding reduces the risk of electric shock by providing an escape wire for the electric current. This appliance is equipped with a cord that has a grounding wire with a grounding plug. The plug must be plugged into an outlet that is properly installed and grounded.

Properly polarized and grounded outlet

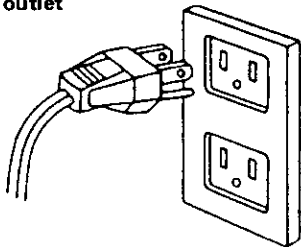

Three-pronged (grounding) plug

Consult a qualified electrician if the grounding instructions are not completely understood as to whether the appliance is properly grounded.

A short power supply cord is provided to reduce the risk of becoming entangled in or tripping over a longer cord.

Longer cord sets or extension cords may be used with following precautions:

- The marked electrical rating of the cord set or extension cord should be equal to or higher than the electrical rating of the appliance.
- The extension cord must be a grounding type 3-wire cord.
- A longer cord should be arranged so that it will not drape over the countertop or tabletop where it can be pulled on by children or tripped over accidentally.

The electrical power cord must be kept dry and must not be pinched or crushed in any way.

WARNING - Electric Shock Hazard

Improper use of the grounding plug can result in electric shock.

Do not plug into an outlet until appliance is properly installed and grounded.

WARRANTY

KENMORE MICROWAVE OVEN FULL ONE YEAR WARRANTY

For one year from the date of purchase, if this Kenmore Microwave Oven fails due to a defect in material or workmanship, Sears will repair it, free of charge.

KENMORE MAGNETRON FULL FIVE YEAR WARRANTY

For five years from the date of purchase, if the magnetron in this Kenmore Microwave Oven fails due to a defect in material or workmanship, Sears will repair it, free of charge.

The above warranty coverage applies only to microwave ovens which are used for private household purposes.

Warranty service is available by simply **RETURNING MICROWAVE TO SEARS SERVICE CENTER** in the United States.

This Warranty applies only while this product is in use in the United States.

The Warranty give you specific legal rights, and you may also have other rights which vary from state to state.

**SEARS, ROEBUCK AND CO.,
DEPT. 817 WA,
HOFFMAN ESTATES, IL. 60179**

For Service Call:

1 - 800 - 4 - REPAIR
1 - 800 - 473 - 7247

TABLE OF CONTENTS

Before Operation

Safety Instructions
PRECAUTIONS TO AVOID POSSIBLE EXPOSURE TO EXCESSIVE MICROWAVE ENERGY inside cover
 For Your Assistance inside cover
 Proper and Safe Use of Your Oven inside cover
 Important Safety Instructions 1
 Electrical Grounding Instructions 2

Setting up & Getting to Know Your Oven
 Warranty 2
 Table of Contents 3
 Specifications 3
 Names of Oven Parts and Accessories 4
 Installation 5
 Control Panel and Features 6
 Setting Clock 7
 Child Lock-Out 7
 Utensils 8

Operation

Operating Instructions
 Automatic Popcorn 9
 Quick-On Cooking 9
 Automatic Defrost by Weight 10
 Quick Touch Cooking 11
 Time Cooking 12
 Minute Timer 13
 Multistage Cooking 13

Chart

Quick-On Cooking Chart 14
 Automatic Defrost Chart 15

Maintenance

Questions and Answers 16
 Cleaning 17
 Sears Service 17
 Before Calling for Service 18

Instrucciones en español

Instrucciones de seguridad
PRECAUCIONES PARA EVITAR LA POSIBLE EXPOSICION A EXCESIVA ENERGIA DE MICROONDAS 19
 Instrucciones importantes de seguridad 20
 Instrucciones de toma de tierra electrica. 21

Para preparar y conocer su horno
 Garantia 21
 Instalacion 22
 Panel de controles y funciones 23
 Ajustando el reloj 24
 Seguro contra niños 24

Instrucciones de operacion
 Palomitas de maiz automaticamente 25
 Cocinando rapidamente 25
 Descongelado automatico por peso 26
 Accion rapida para recalentar 27
 Accion rapida para cocinar comida congelada 27
 Tiempo de cocinado 28
 Alarma por minuto 29
 Cocinando en etapas multiples 29

SPECIFICATIONS

Model	565.66100 / 565.66101
Power Source	AC 120 V, 60 Hz
Power Consumption	8 Amps, 920W
Maximum Output	600W (IEC-705 test procedure)
Oven Capacity	0.6 cu. ft.
Turntable Diameter	10-13/16" (275 mm)
Dimensions (w x h x d)	18" x 9-7/8" x 13-5/16" (461 mm x 250 mm x 346 mm)
Weight (Approx.)	25.0 lbs. (11.4 kg)

Specifications subject to change without notice.
 KENMORE is a registered trademark of Sears, Roebuck and Co..

NAMES OF OVEN PARTS AND ACCESSORIES

Remove the oven and all materials from the carton.
Your oven comes with the following accessories:

Turntable	1
Turntable roller rest	1
Owner's Manual	1

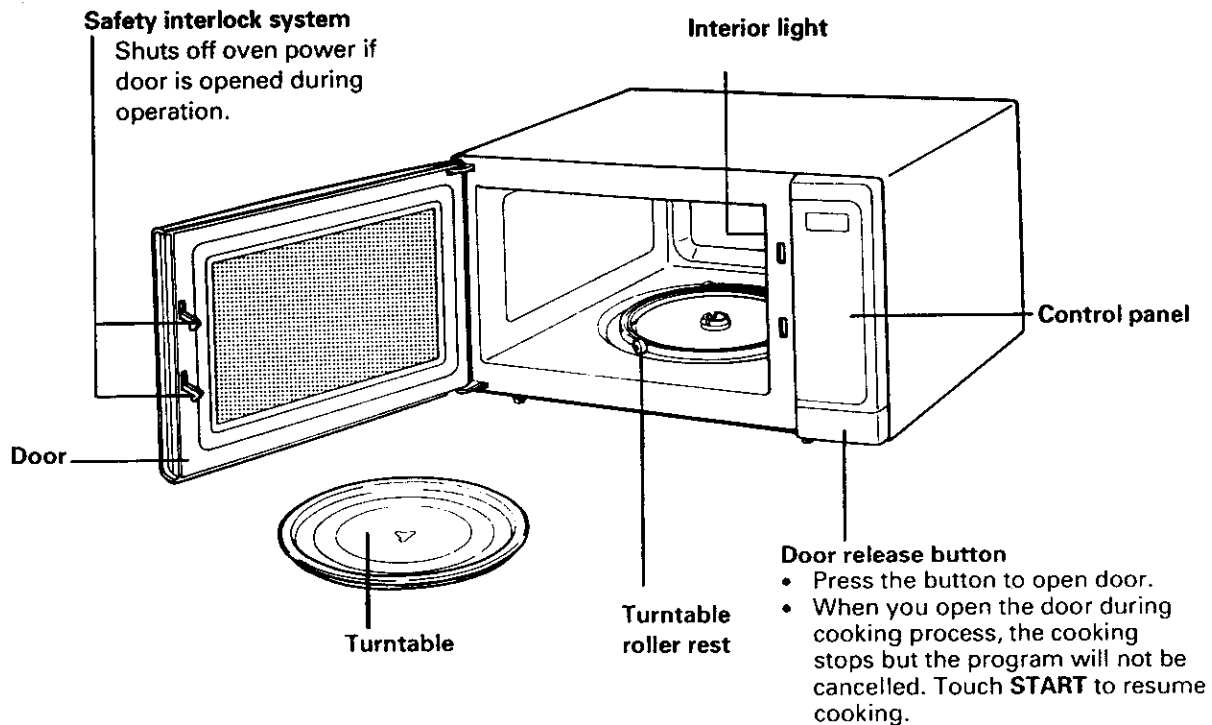

TURNTABLE INSTALLATION

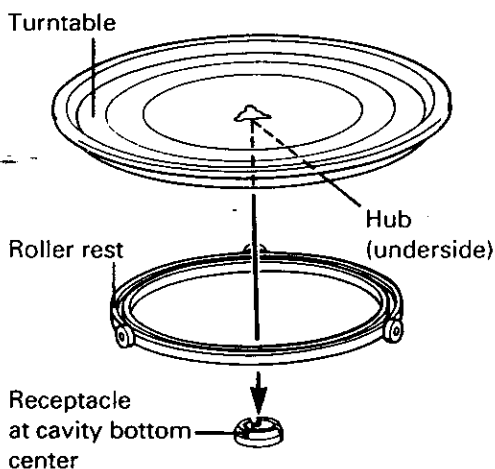

1. Place the roller rest on the cavity bottom.
 2. Place the turntable on top of the roller rest as shown in the diagram. Make sure the turntable hub is securely locked in the receptacle. **Never place the turntable upside down.** The turntable rotation should never be restricted.
- Both turntable and roller rest must always be used during cooking.
 - All food and containers of food are always placed on this turntable for cooking.
 - **This turntable returns to its original starting position** when cooking is finished. The light and fan will remain on but microwave power is turned off.
 - This turntable rotates clockwise or counterclockwise; this is normal.

INSTALLATION

Before Operation

Remove all packing material and accessories. Examine the oven for any damage such as dents or broken door. Do not install if oven is damaged.

1. Select a level surface that provides enough open space (see illustration at right) for the inlet and/or outlet vents.
 - Leave a minimum clearance of 3 inches (7.5 cm) above the oven.
 - Do not remove the legs from the bottom of the oven.
 - Blocking the inlet and/or outlet openings can damage the oven.
 - Do not install oven over a range, cooktop or other heat-producing appliance.
2. Plug your oven into a standard 120-volt / 60-Hz household outlet. Be sure the electrical circuit is at least 15 amperes and that your microwave oven is the only appliance on the circuit.

To install the oven under the cabinet, optional mounting kit, Stock No. 20-84339 (White) or 20-66900 (Black) is available. Contact your Sears store. On installation of mounting kit, 1 inch (2.5 cm) must be allowed on both sides of oven and 4 inches (10 cm) must be allowed under bottom of oven.

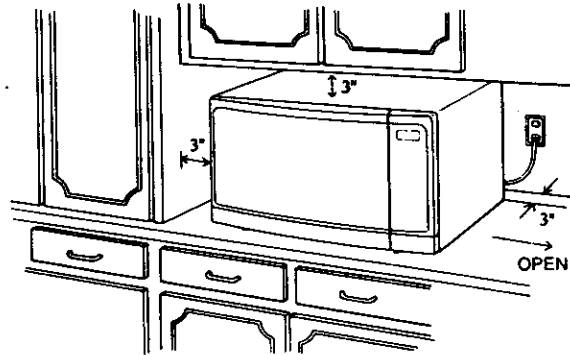

A minimum clearance of 3 inches (7.5 cm) is required between the oven and any adjacent wall. One side must be open.

NOTE:

This unit is not designed for 50 Hz or any circuit other than a 120-volt/60-Hz AC circuit. This oven is designed for countertop or under-cabinet installation. Insertion into a cabinet or wall will damage the product and void the warranty.

CONTROL PANEL AND FEATURES

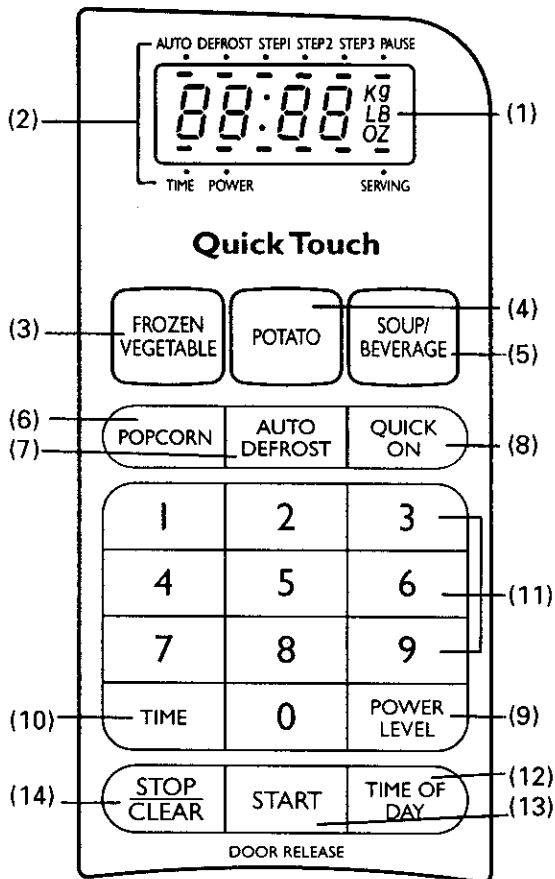

(1) Display Window

Counts down cooking time in seconds.
Shows clock time when oven is not in use.

(2) Indicators

STEP1/ STEP2/ STEP3 :

Cooking stage indicators

AUTO/ DEFROST/ PAUSE :

Cooking mode indicators

TIME/ POWER/ SERVING/ LB/ OZ :

A flashing indicator prompts you to enter desired cooking time, power setting, number of servings or food weight.

Quick Touch menu keypads (page 11)

(3) FROZEN VEGETABLE

(4) POTATO

(5) SOUP/BEVERAGE

Auto menu keypads

(6) POPCORN (page 9)

(7) AUTO DEFROST (page 10)

(8) QUICK ON (page 9)

(9) POWER LEVEL keypad (page 12)

(10) TIME keypad (page 12)

(11) Number keypad

(12) TIME OF DAY keypad (page 7)

(13) START keypad

(14) STOP/CLEAR keypad

Clears all previous setting if pressed before cooking starts. During cooking: touch once to stop oven; twice to stop and clear all entries.





Beep Sound

A beep tone sounds when a keypad on the control panel is touched to indicate a setting has been entered.

SETTING CLOCK

When your oven is plugged in for the first time or when power resumes after a power interruption, the numbers in the display reset to **0:00**. Set the clock.

Example: To set 3:15 :

1.  Touch **TIME OF DAY**.
2.    Touch number keypads **3**, **1** and **5**.
3.  Touch **TIME OF DAY**.
The clock starts counting.

Remember:



- If the clock (or display) shows any abnormality, unplug the oven from the AC outlet. Plug it in again and then reset the clock.

Before Operation



CHILD LOCK-OUT

Your oven has a safety feature which prevents children from accidentally turning it on. Even if the oven is accidentally programmed to cook, no cooking takes place when this feature is set.

To set :

1.  Touch **TIME OF DAY**.
2. 
4 times
Touch **9** four times.
3.  Touch **START**.
Indicator **L** lights and clock display reappears.

To cancel :

1.  Touch **TIME OF DAY**.
2. 
4 times
Touch **7** four times.
3.  Touch **START**.
Indicator **L** disappears and clock display reappears.

UTENSILS

MATERIALS YOU CAN USE IN MICROWAVE OVEN

Utensils	Use	Remarks
Aluminum foil	Shielding	Small smooth pieces can be used to cover thin parts of meat or poultry to prevent overcooking. Arcing can occur if foil is too close to oven walls. The foil should be at least 1 inch (2.5 cm) away from oven walls.
Browning dish	Searing meats	Follow manufacturer's instructions. The bottom of browning dish must be at least $\frac{3}{16}$ inch (5 mm) above the turntable. Incorrect usage may cause the turntable to break.
Dinnerware	Reheating and short-term cooking	Microwave-safe only. Follow manufacturer's instructions. Do not use cracked or chipped dishes.
Glass jars	Warming	Always remove lid. Use only to heat food until just warm. Most glass jars are not heat resistant and may break.
Glassware	Cooking	Heat-resistant oven glassware only. Make sure there is no metallic trim. Do not use cracked or chipped dishes.
Oven cooking bags	Cooking	Follow manufacturer's instructions. Do not close with metal tie. Make slits to allow steam to escape.
Paper plates and cups	Short-term warming and cooking	Use for short-term cooking/warming only. Do not leave oven unattended while cooking.
Paper towels	Reheating and short-term cooking	Use to cover food for reheating and absorbing fat. Use with supervision for a short-term cooking only.
Parchment paper	Cooking	Use as a cover to prevent spattering or a wrap for steaming.
Plastic	Reheating and short-term cooking	Microwave-safe only. Follow the manufacturer's instructions. Should be labeled "Microwave Safe." Some plastic containers soften as the food inside gets hot.
Plastic wrap	Cooking	Microwave-safe only. Use to cover food during cooking to retain moisture. Do not allow plastic wrap to touch food.
Thermometers	Cooking	Microwave-safe only (meat and candy thermometers).
Wax paper	Cooking	Use as a cover to prevent spattering and to retain moisture.

MATERIALS TO BE AVOIDED IN MICROWAVE OVEN

Utensils	Remarks
Aluminum tray	Aluminum tray may cause arcing. Transfer the food into a microwave-safe dish before cooking.
Food carton with metal handle	May cause arcing. Transfer food into microwave-safe dish.
Metal or metal-trimmed utensils	Metal shields the food from microwave energy. Metal trim may cause arcing.
Metal twist ties	They may cause arcing and could cause a fire in the oven.
Paper bags	May cause a fire in the oven.
Plastic foam cups	Plastic foam may melt or contaminate the liquid inside when exposed to high temperature.
Wood	Wood will dry out when used in the microwave oven and may split or crack.

UTENSIL TEST: Fill a microwave-safe container with 1 cup of cold water (250 mL) and place it in the oven along with the utensil in question. Cook on **HI** power for 1 minute. Carefully feel the utensil. If the empty utensil is warm, it should not be used for microwave cooking. **Do not exceed 1 minute testing time.** This test cannot be used for plastic containers.



CAUTION - Personal Injury Hazard

Tightly-closed utensils could explode.

Closed containers are opened and plastic pouches pierced before cooking.

AUTOMATIC POPCORN

This feature lets you pop a 3.5-oz (100-g) or 3.0-oz (85-g) prepackaged microwave popcorn quickly and easily.

Popcorn Popping Tips:

- Microwave popcorn bag should be at room temperature.
- Place only one bag in the oven at a time. Follow package instructions. Do not increase quantity.
- Popcorn popping devices are not recommended for use with this feature.

Example: To pop one bag of 3.5-oz (100-g) microwave popcorn:

1.



Touch **POPCORN** once. Display shows bag size. Select bag size as follows.

Bag Size	Touch POPCORN
3.5 oz (100 g)	once
3.0 oz (85 g)	twice

2.



Touch **START**. The display shows the time counting down.

Remember:

- If popcorn bag size is not 3.5 oz (100 g) or 3.0 oz (85 g), do not use this feature. Follow instructions on the package.
- Do not leave the oven unattended while the corn is being popped.
- Remember to supervise children closely.

CAUTION - Personal Injury Hazard

- * After popping, open bag carefully. Popcorn and steam are extremely hot.
- * Do not reheat unpopped kernels or reuse bag. Overcooking can result in an oven fire.
- * Never use a brown paper bag for popping corn.

Operation

QUICK-ON COOKING (HI-POWER)

A time-saving feature, this simplified control lets you quickly set and start microwave cooking without the need to touch **START**.

You can choose from ten preset cooking time selections (30 seconds to 9 minutes) to cook at highest power level (**HI**). Quick-On cooking chart is located on page 14.

30 seconds Cooking
To set Quick-On cooking for 30 seconds, touch **QUICK ON** and **0**.

Example: To set Quick-On cooking for 2 minutes:

1.



Touch **QUICK ON**.

2.

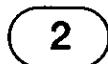

Touch **2**. The oven begins cooking and display shows time counting down.

Remember:

- You may open the door to stop cooking before the selected time is over. To start again, close the door and touch **START**.

AUTOMATIC DEFROST BY WEIGHT

The Auto Defrost by Weight feature is an accurate defrosting method for frozen food up to 5.9 lb. The oven automatically selects 1 lb. If food weight is more or less than 1 lb, enter the weight using the number keypads.

Pause

This feature has a built-in pause mechanism to allow for checking, turning, separating or rearranging the food. When the PAUSE indicator flashes in the display (and the beep tone sounds 5 times), open the door and rearrange the food. If you do not open the door at the pause, the oven automatically starts the second defrost period.





Auto Defrosting chart is located on page 15.

For manual defrosting using Time Cooking, see page 12.

Defrosting Tips:

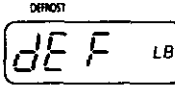
- Check the food during defrosting.
- Remove frozen food from its original paper or plastic wrap. When it is difficult to remove the wrap, defrost the food in the wrap until the Pause. At the pause, remove the wrap.
- Place foods in a flat microwave-safe baking dish or roasting rack to catch drippings.
- Food should still be somewhat icy in the center when removed from the oven.
- The Auto Defrost menu includes standing time.
- Food can be defrosted in a styrofoam package.

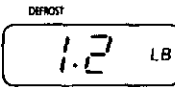
Example: To defrost 1.2 lb of chicken pieces:

1.  Touch **AUTO DEFROST**.

2.   Enter the weight by touching **1** and then **2**.

3.  Touch **START**. Indicator **STEP1** lights and the total defrost time appears in the display.
4. After the first stage of cooking, the beep tone sounds 5 times. The indicator changes from **STEP1** to **STEP 2** and the **PAUSE** indicator flashes for 5 seconds. Open the door and separate, rearrange or turn food over.
5.  Touch **START** to resume defrosting.

Remember:

- To enter a weight of less than 1 lb, always press **0** first. For example, to enter 0.2 lb, press **0** and then **2**.
- Only one digit can be entered after a decimal point. If in doubt, convert to the lower number.

Conversion Chart	
Ounces	Tenths of a Pound
1 - 2	0.1
3 - 4	0.2
5	0.3
6 - 7	0.4
8	0.5
9 - 10	0.6
11 - 12	0.7
13	0.8
14 - 15	0.9

QUICK TOUCH COOKING

FROZEN VEGETABLE keypad allows you to heat precooked frozen vegetables.
POTATO keypad allows you to cook 1 to 3 potatoes.
SOUP/BEVERAGE keypad allows you to reheat 1 to 3 servings of liquids.
 The oven automatically determines required cooking time and power for each food item according to your keypad entry.

Cooking Tips

Frozen Vegetable:

- Follow package directions for removing or venting cover, piercing pouch, replacing foil, covering with plastic wrap, etc.
- For best results, remove frozen vegetables from aluminum or foil containers and place on microwave-safe plate or dish.

Potato:

- Arrange in a circular pattern with heavier ends pointing toward the outer edge of the turntable.
- Potatoes must be room temperature.
- Follow the directions included in the chart.

Soup/Beverage:

- Liquids must be room or refrigeration temperature.
- Stir after reheating.
- Follow the directions included in the chart.

Example: To reheat 2 servings of soup :

1.



Touch **SOUP/BEVERAGE** twice.

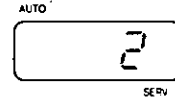

Enter the food weight, the number of potatoes or the number of servings by touching a desired menu keypad as shown in the chart below.

Touch menu keypad	once	twice	3 times
FROZEN VEGETABLE	5 oz	10 oz	20 oz
POTATO	1 potato	2 potatoes	3 potatoes
SOUP/BEVERAGE	1 serving	2 servings	3 servings

2.



Touch **START**.
 The display changes to cooking time countdown.

Item	Amount	Directions
POTATO	1 potato (6 oz or 170 g)	Pierce with fork. Place on a paper towel. Touch menu keypad once. Let stand 3 - 5 minutes.
SOUP/BEVERAGE Coffee/Tea Soup Hot Chocolate	1 serving (8 oz or 230 mL)	No cover. Stir after reheating. Cover. Stir after reheating. No Cover. Stir after reheating.

Note: Use microwave-safe cup only.

Remember:

FROZEN VEGETABLE

- Follow package directions for adding water, piercing pouch, cooking in dish, venting package, etc.

TIME COOKING

This basic microwave cooking method allows you to cook food for a desired time. In addition to the HI (maximum) power level, you can select different microwave power from 9 levels, 1 (10% of HI power level) to 9 (90% of HI power level) for the foods that require slower cooking. The oven also provides power level 0 (no power) so that the clock can be utilized as a minute timer. See page 13 for details.









Foods with high moisture content should be cooked on maximum power, as this is the fastest cooking method and best maintains the natural flavor and texture of the foods.

To check the power level during cooking, touch **POWER LEVEL**. The power level appears in the display window.

Manual Defrosting

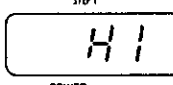
For manual defrosting (without using Auto Defrost features), use power level 3. To speed up the defrosting of dense foods over 1 lb (450 g), you may start on **HI** for 2 minutes, then reduce to the level 3.

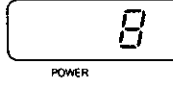
Example: To cook at power level 8 for 40 seconds:

1.  Touch **TIME**.
2.   Enter 40 seconds by touching 4 and then 0.
3.  Touch **POWER LEVEL**.  STEP 1
POWER
4.  Touch 8 to select power level 8. The display shows 8.  STEP 1
POWER
5.  Touch **START**.

Remember:

- Cooking time can be set up to 99 minutes 99 seconds.
- When you cook on **HI** power, skip steps 3 and 4.







POWER LEVEL SETTING GUIDE

Power Level	Cooking Examples
1	<ul style="list-style-type: none"> • Softening cream cheese and butter. • Keeping casseroles and main dishes warm.
2	<ul style="list-style-type: none"> • Softening chocolate and clarifying butter. • Heating breads, rolls, pancakes, tacos, tortillas and French toast. • Taking the chill out of fruit. Heating small amounts of food.
3	<ul style="list-style-type: none"> • Completing the cooking cycle of casseroles, stews and sauces. • Manual defrosting. • Thawing meat, poultry and seafood.
4	<ul style="list-style-type: none"> • Cooking less tender cuts of meat in liquid or slow-cooking dishes. • Completing the cooking cycle of less tender roasts.
5	<ul style="list-style-type: none"> • Cooking stews and soups after bringing to a boil. • Cooking custards and pasta. • Cooking rump roast, ham, veal and lamb.
6	<ul style="list-style-type: none"> • Cooking scrambled eggs. Baking cakes.
7	<ul style="list-style-type: none"> • Cooking cheese dishes.
8	<ul style="list-style-type: none"> • Reheating precooked or prepared food quickly. Cooking fish.
9	<ul style="list-style-type: none"> • Cooking onions, celery and green peppers quickly. • Reheating rice and pasta.
HI	<ul style="list-style-type: none"> • Cooking poultry, vegetables and most casseroles. • Preheating a browning dish. Boiling water.

MINUTE TIMER

You can use the timer function of your oven for purposes other than cooking.

Example: To set 3 minutes for a telephone call:

1.  Touch **TIME**.
2.    Touch **3** , **0** and **0**.
3.  Touch **POWER LEVEL**.
4.  Touch **0** (power level 0).
5.  Touch **START**.

Operation

MULTISTAGE COOKING

- You can program up to 3 stages of cooking in sequence. To program 2-stage or 3-stage cooking, repeat the Time Cooking steps 1 to 4 on the previous page and touch **START**.
- Using the Minute Timer feature for the first stage, you can delay cooking start time by up to 99 minutes and 99 seconds.
- Using the Auto Defrost by Weight feature for the first stage, you can defrost first and can program up to 3 stages of cooking.

QUICK-ON COOKING CHART

REHEATING Item	Amount	Time	Special Notes
Beverage			
Water-based	1 cup (250 mL)	1 - 2 min.	Heat uncovered. Stir after heating.
	2 cups (500 mL)	3 - 4 min.	
Milk-based	1 cup (250 mL)	1 - 2 min.	
	2 cups (500 mL)	3 - 4 min.	
Soups			
Broth-based	10¾ oz (300 mL) can	3 - 4 min.	Use microwave-safe casserole. Cover. Stir after heating.
Cream-based	10¾ oz (300 mL) can	3 - 5 min.	
Cooked pizza			
10 inch pizza cut into 8 portions	2 wedges	1 - 2 min.	Place on paper towels or paper plate or leave in uncovered cardboard box. Points toward center.
	4 wedges	2 - 3 min.	
	whole	3 - 4 min.	
Meat			
Sliced thin	3 - 5 oz (85 -140 g)	1 - 2 min.	Heat on microwave-safe plate, covered with wax paper.
Sliced thick, 1" (2.5 cm)	3 - 5 oz (85 -140 g)	2 - 3 min.	
Chili, stews	2 cups (500 g)	3 - 5 min.	Place in microwave-safe dish. Cover. Stir halfway through cooking time.
Hamburgers, meat loaf slices, sausage patties	1 serving	½ - 1 min.	Place on microwave-safe plate. Cover with paper towel. Turn over once.
	2 servings	1 - 2 min.	
	4 servings	2 - 4 min.	
Poultry			
Chicken pieces	1	1 - 2 min.	Heat on microwave-safe plate. Cover with wax paper. If fried, cover with paper towel.
	2	2 - 3 min.	
	4	3 - 5 min.	
	6	4 - 6 min.	
Chicken, turkey, sliced	3 - 5 oz (85 -140 g)	1 - 3 min.	Heat on microwave-safe plate. Cover with wax paper.
Seafood			
Shrimp, crab, or scallops in sauce, frozen	6½ oz (185 g)	4 - 6 min.	Pierce pouch and place on microwave-safe plate. Flex pouch to mix halfway through cooking time.
Seafood or fish casserole, frozen	16 oz (450 g)	5 - 7 min.	Remove from package to a microwave-safe casserole. Cover. Stir once during cooking.
Cooked rice, pasta			
	¾ cup (175 mL)	1 - 2 min.	Heat in microwave-safe casserole, covered with plastic wrap.
	1 - 2 cups (250 - 500 mL)	2 - 4 min.	
Vegetable, frozen in pouch	10 - 12 oz (280 - 340 g)	4 - 6 min.	Pierce pouch. Place on microwave-safe plate. Flex pouch to mix halfway through cooking time.
Canned vegetable			
	8 oz (230 g)	1 - 2 min.	Use microwave-safe casserole, covered. Stir once.
	15 oz (425 g)	2 - 4 min.	
	18 oz (500 g)	3 - 5 min.	
COOKING Item			
Mashed potatoes, instant			
	4 servings	4 - 6 min.	Follow package directions. Reduce liquid by 1 tbsp (15 mL).
Pudding and pie filling mix			
	3¼ oz (90 g)	5 - 7 min.	Follow package directions. Stir once.
Cereals			
Cream of wheat (regular)	¼ cup (50 mL)	1 - 3 min.	Add ¾ cup (175 mL) of water. Cook uncovered. Stir once. Let stand 1 minute. Add 1½ cup (375 mL) of water. Cook uncovered. Stir once. Let stand 1 minute.
	½ cup (125 mL)	3 - 5 min.	
Wheat-bran cereal	¼ cup (50 mL)	1 - 3 min.	Add ¾ cup (175 mL) of water. Cook uncovered. Stir once. Let stand 1 minute. Add 1½ cup (375 mL) of water. Cook uncovered. Stir once. Let stand 1 minute.
	½ cup (125 mL)	3 - 5 min.	

AUTOMATIC DEFROST CHART

- Set Auto Defrost by Weight according to instructions on page 10.
- Remove food from wrapper and place in a microwave-safe dish or place on a microwave-safe roasting rack.
- Cover thin parts with aluminum foil.
- Large roasts should be still icy in center. Allow to stand.
- Fish and seafood should also be slightly icy.
- Food can be defrosted in a styrofoam package.
- Some types of food will need to be rearranged at the Pause.

Item	Special Notes
Beef	
Ground beef	Turn over and remove defrosted portion at pause.
Liver	Drain liquid as it defrosts. Separate pieces.
Roasts	Turn over at pause. Cover ends with foil.
Sirloin steak	Turn over at pause.
Rib or T-bone	Turn over at pause.
Flank steak	Turn over at pause.
Stewing meat	Break apart at pause.
Pork	
Bacon	Defrost in original wrapper. Turn over at pause. Center should be slightly icy.
Chops	Separate and turn over at pause.
Ribs	Turn over at pause.
Roasts	Turn over at pause. Cover ends with foil.
Lamb	
Chops	Separate and turn over at pause.
Ribs	Turn over at pause.
Roasts	Turn over at pause. Cover ends with foil.
Poultry	
Chicken, whole, up to 3 lb - 2 oz (1.4 kg)	Check for and remove any metal clamps or wires before defrosting. Turn over at pause. Cover ends with foil. Rinse under cold water.
Pieces	Separate and turn over at pause.
Cornish hens	Check for and remove any metal clamps or wires before defrosting. Turn over at pause. Rinse under cold water.
Fish and Seafood	
Crabmeat, shrimp	Break apart at pause.
Fish fillets	Turn over and rearrange at pause. Rinse under cold water to separate.
Fish whole, steaks	Turn over at pause. Cover head and tail with foil.
Scallops	Break apart at pause. Remove defrosted scallops.

QUESTIONS AND ANSWERS

OPERATION

- Q.** What is wrong when the oven light will not glow?
- A.** There may be several reasons why the oven light will not glow.
- The light bulb has burned out.
 - **START** has not been touched.
- Q.** Why is steam coming out of the air exhaust vent?
- A.** Steam is normally produced during cooking. The microwave oven has been made to vent this steam.
- Q.** Can the microwave oven be damaged if it operates empty?
- A.** Yes. Never operate while empty or without the turntable positioned correctly on the roller rest.
- Q.** When the oven is plugged into a wall outlet for the first time, it might not work properly. What is wrong?
- A.** When the oven is plugged in for the first time or when power resumes after a power interruption, the microcomputer used in the oven control may temporarily become scrambled and fail to function as programmed. Unplug the oven from the wall outlet and then plug it back in. The microcomputer will then reset for proper functioning.
- Q.** Why do I see light reflection around the outer case?
- A.** This light is from the oven light located outside the oven cavity.
- Q.** Why is there noise coming from the turntable when the oven is turned on?
- A.** This noise occurs when the turntable roller rest and cavity bottom are dirty. Frequent cleaning of these parts should eliminate or reduce the noise.
- Q.** Instructions for aluminum foil use are confusing. When should I use foil?
- A.** It should be used to shield portions of food from becoming overcooked or overdefrosted. Use small flat pieces of foil for shielding. (Refer to page 8)

FOODS

- Q.** What is wrong when baked foods have a hard, dry, brown spot?
- A.** This is caused by overcooking. Shorten cooking or reheating time.
- Q.** Why do eggs sometimes pop?
- A.** The egg yolk may pop because of steam build-up inside the membrane. To prevent this, simply pierce the membrane with a toothpick before cooking it.
- CAUTION: Never microwave eggs in the shell since they may explode.**
- Q.** Why are scrambled eggs sometimes a little dry after cooking?
- A.** Eggs dry out if they are overcooked. You may need to vary the cooking time for one of these reasons:
- Eggs vary in size.
 - Eggs are at room temperature one time and at refrigerator temperature another time.
 - The shapes of utensils vary, which makes it necessary to vary cooking time.
 - Eggs continue cooking during standing time.
- Q.** What is wrong when three potatoes bake thoroughly and the fourth one is still not cooked?
- A.** The fourth potato may be slightly heavier than the others and should be cooked 30 to 60 seconds longer. Remember to allow one inch (2.5 cm) around each potato when baking. For more even cooking, place potatoes in a circle.
- Q.** Why do baked apples sometimes burst during cooking?
- A.** As in regular cooking methods, steam is formed in the interior of the apple, causing it to swell and expand during the cooking process.
- Q.** How are boil-overs avoided?
- A.** Use a larger utensil than usual for cooking. If you open the oven door or touch **STOP/CLEAR**, the food will stop boiling.
- Q.** Why does the dish become hot when I microwave food in it?
- A.** As the food becomes hot it will conduct the heat into the dish. Use oven mitts to remove food after cooking.

CLEANING

Wipe the oven inside and outside with a soft cloth and a mild detergent solution. Then rinse and wipe dry. This should be done on a weekly basis - more often if needed. Never use cleaning powders or rough pads. Excessive oil splatters on the inside top will be difficult to remove if left for many days. Wipe spatters with a wet paper towel, especially after cooking chicken or bacon.

REMOVABLE PARTS

The following parts may be removed as described. They should be washed in warm (not hot) water with a mild detergent and a soft cloth. Once they are clean, rinse them well and dry with a soft cloth. Never use cleaning powders, steel wool or rough pads.

- The turntable may be cleaned at the sink. Be careful not to chip or scratch the edges as this may cause the turntable to break during use.
- The turntable roller rest should be cleaned regularly.

SPECIAL CARE

For best performance and safety, the inner door panel and the oven front frame should be free of food or grease buildup. Wipe them often with a mild detergent. Then rinse and wipe dry. Never use cleaning powders or rough pads.

After cleaning the control panel, touch **STOP/CLEAR** to clear any entries that might have been entered accidentally while cleaning the panel.



CAUTION - Product Damage Hazard

Uncleaned cavity cover (located in the right side wall of the oven cavity) will cause fire, burn or sparking.

Clean your oven with wet towel.

SEARS SERVICE

"WE SERVICE WHAT WE SELL"

"We Service What We Sell" is our assurance to you that you can depend on Sears for service because Sears Service is nationwide.

Your Sears Kenmore Microwave Oven has added value when you consider that Sears has a service unit near you, staffed by Sears Trained Technicians-professional technicians specifically trained on Sears Kenmore Microwave Ovens, having the parts, tools and equipment to insure that we meet our pledge to you-"We Service What We Sell!"

TO FURTHER ADD TO THE VALUE OF YOUR MICROWAVE OVEN, BUY A SEARS MAINTENANCE AGREEMENT.

Sears Kenmore Microwave Ovens are designed, manufactured, and tested for years of dependable operation. Yet, any modern appliance may require service from time to time. A Sears Maintenance Agreement is more than an extension of the Warranty.

It provides complete protection from unexpected repair bills and undue inconvenience. It assures you of maximum efficiency from your Microwave Oven.

Here's a comparative warranty and Maintenance Agreement chart showing you the benefits of a Sears Microwave Oven Maintenance Agreement.

YEARS OF OWNERSHIP COVERAGE	1 st Yr.	2 nd Yr. thru 5 th Yr.
1.Replacement of defective parts other than magnetron	W	MA
2.Replacement of magnetron	W	W
3.Annual preventive maintenance check at your request	MA	MA

W-WARRANTY

MA-MAINTENANCE AGREEMENT

Contact your Sears salesperson or local Sears Service Center today and purchase a Sears Maintenance Agreement.

Maintenance

BEFORE CALLING FOR SERVICE

You can often correct operating problems yourself. If your microwave oven fails to work properly, check your problem by using the chart below and try the solutions for each problem. If the microwave oven still does not work properly, contact the nearest authorized service center.

PROBLEM	POSSIBLE CAUSE	POSSIBLE SOLUTION
Oven will not start	<ol style="list-style-type: none"> 1. Electrical cord for oven is not plugged in. 2. Door is open. 3. Wrong operation is set. 	<ol style="list-style-type: none"> 1. Plug into the outlet. 2. Close the door and try again. 3. Check instructions, (pages 9-13)
Err appears in the display window	<ol style="list-style-type: none"> 1. Wrong operation is set. 	<ol style="list-style-type: none"> 1. Touch STOP/CLEAR.
Arcing or sparking	<ol style="list-style-type: none"> 1. Materials to be avoided in microwave oven are used. 2. The oven is operated when empty. 3. Food refuse remains in the cavity or inside the cavity is uncleaned. 	<ol style="list-style-type: none"> 1. Use microwave-safe cookware only, (page 8) 2. Do not operate with oven empty. 3. Clean cavity with wet towel.
Unevenly cooked foods	<ol style="list-style-type: none"> 1. Materials to be avoided in microwave oven are used. 2. Food is not defrosted completely. 3. Cooking time/ Cooking power level is not suitable. 4. Food is not turned or stirred. 	<ol style="list-style-type: none"> 1. Use microwave-safe cookware only, (page 8) 2. Completely defrost food. 3. Use correct time/cooking power level. 4. Turn or stir food.
Overcooked foods	<ol style="list-style-type: none"> 1. Cooking time/ Cooking power level is not suitable. 	<ol style="list-style-type: none"> 1. Use correct time/cooking power level.
Undercooked foods	<ol style="list-style-type: none"> 1. Materials to be avoided in microwave oven are used. 2. Food is not defrosted completely. 3. Oven ventilation ports are restricted. 4. Cooking time/ Cooking power level is not suitable. 	<ol style="list-style-type: none"> 1. Use microwave-safe cookware only, (page 8) 2. Completely defrost food. 3. Check to see that oven ventilation ports are not restricted. 4. Use correct time/cooking power level.
Improper defrosting	<ol style="list-style-type: none"> 1. Materials to be avoided in microwave oven are used. 2. Cooking time/ Cooking power level is not suitable. 3. Food is not turned or stirred. 	<ol style="list-style-type: none"> 1. Use microwave-safe cookware only, (page 8) 2. Use correct time/cooking power level. 3. Turn or stir food.

For in-home major brand repair service:
Call 24 hours a day, 7 days a week
1-800-4-MY-HOMESM (1-800-469-4663)

Para pedir servicio de reparación a domicilio - 1-800-676-5811

In Canada for all your service and parts needs call **- 1-800-665-4455**
Au Canada pour tout le service ou les pièces

For the repair or replacement parts you need:
Call 7 am - 7 pm, 7 days a week
1-800-366-PART (1-800-366-7278)

Para ordenar piezas con entrega a domicilio - 1-800-659-7084

For the location of a Sears Parts and Service Center in your area:
Call 24 hours a day, 7 days a week
1-800-488-1222

**For information on purchasing a Sears Maintenance Agreement
or to inquire about an existing Agreement:**
Call 9 am - 5 pm, Monday - Saturday
1-800-827-6655



The Service Side of SearsSM